

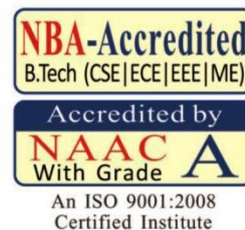

Devineni Venkata Ramana & Dr.Hima Sekhar
MIC College of Technology
(Approved by AICTE & Permanently Affiliated to JNTUK, Kakinada)
Kanchikacherla - 521180, Krishna Dist, A.P, India.
Phone : 08678 - 273535, 273623, Fax: 08678 - 273569
e mail: dvrhsmic@mictech.ac.in, Website: www.mictech.ac.in



ACADEMIC REGULATIONS (MIC18) FOR M Tech (REGULAR) **(CHOICE BASED CREDIT SYSTEM)**

Applicable for the students of M Tech (Regular) from the Academic Year 2018-19

1. ELIGIBILITY CRITERIA FOR ADMISSION

The eligibility criteria for admission into M. Tech programme shall be as per the guidelines issued by the Andhra Pradesh State Council of Higher Education (APSCHE) or by any other competent authority.

2. PROGRAMMES OFFERED (M Tech)

A student shall be offered admission into any one AICTE-approved programme as given below:

S. No	Programme
1	Power Electronics & Electric Drives (ED)
2	Machine Design (MD)
3	VLSI & ES (VE)
4	Computer Science (CS)

3.AWARD OF DEGREE

A student will be declared eligible for the award of M. Tech. degree, if he/she fulfils the following academic requirements:

2 year M Tech programme:

- The student shall pursue a course of study for not less than two academic years and not more than four academic years.
- The student shall register for 68 credits and secure all the 68 credits.
- The students, who fail to fulfill all the academic requirements for the award of degree within four academic years from the year of their admission, shall forfeit their seat in M Tech programme.
- There shall be no disciplinary action pending against the student.

4. MINIMUM INSTRUCTION DAYS

The minimum instruction days for each semester shall be 90 days excluding the days allotted for Mid-term Examinations, Semester-end Examinations and preparation holidays.

5. COURSE CODE DESCRIPTION

For M. Tech Programme

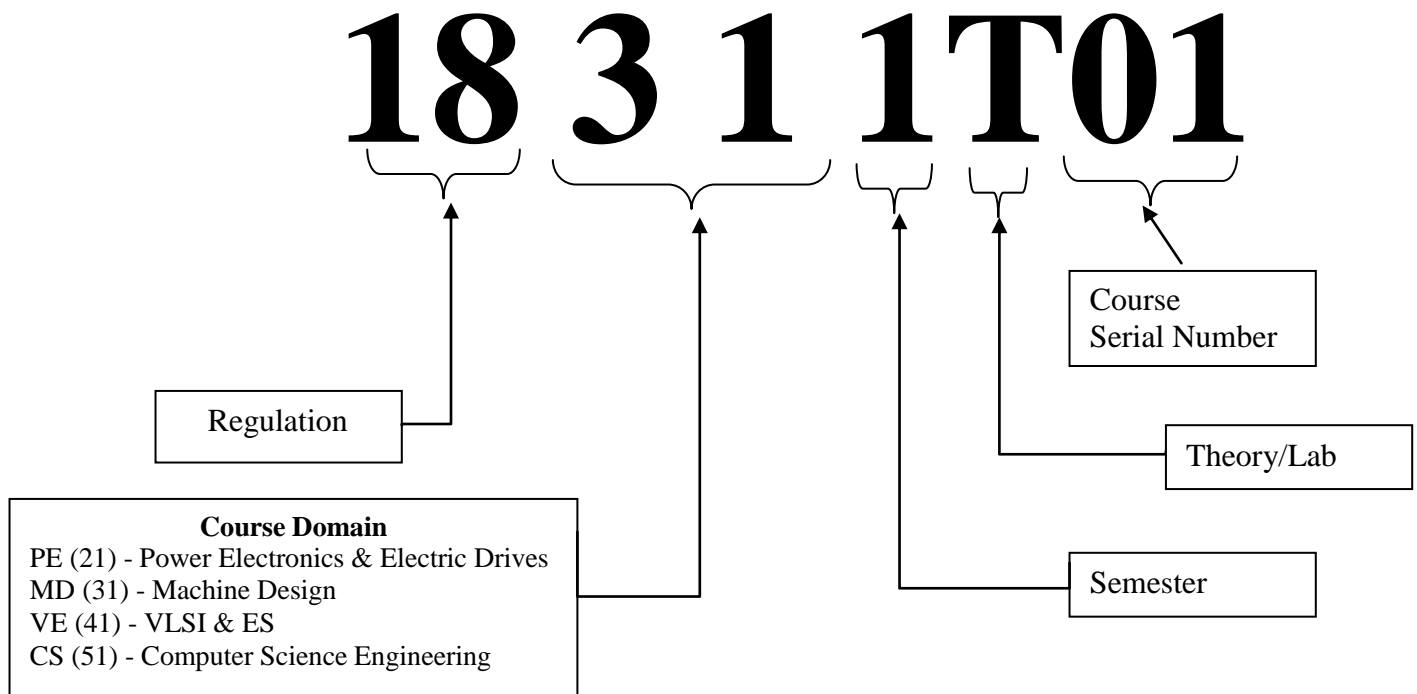

6. ATTENDANCE REQUIREMENTS

- (i) A student is eligible to appear in the Semester-end Examinations only if he/she acquires a minimum of 75% of attendance in aggregate of all the courses.
- (ii) In case of shortage of attendance, condonation up to 10 % in the aggregate will be allowed on valid medical grounds (65% and above and below 75%) in each semester by the college in accordance with the rules stipulated by the affiliating university.
- (iii) A shortage of attendance below 65% in aggregate shall not be condoned under any circumstances.
- (iv) A student whose shortage of attendance is not condoned will be detained and shall have to seek readmission into the same semester.
- (v) A student is required to submit the application along with the valid medical certificate by paying the stipulated fee towards condonation of shortage in attendance.

- (vi) If any student fulfils the attendance requirements in the present semester, he/she shall not be eligible for readmission into the same semester.

7. EVALUATION

The performance of the candidate in each semester shall be evaluated subject-wise, with a maximum of 100 marks for theory and 100 marks for practicals, on the basis of Continuous Internal Evaluation (CIE) and Semester End Evaluation (SEE).

- 7.1 For the theory subjects, 60 marks shall be awarded based on the performance in the SEE and 40 Marks shall be awarded based on the CIE. The internal evaluation shall be made based on the average of the marks secured in the two Mid-term Examinations conducted-one in the middle of the Semester and the other immediately after the completion of instruction. Each Mid-term Examination shall be conducted for a total duration of 120 minutes with 4 questions (without choice), each question for 10 marks. Semester End Examination is conducted for 60 marks where 5 questions are to be answered with internal choice.
- 7.2 For practical subjects, 60 marks shall be awarded based on the performance in the End Semester Examinations and 40 marks shall be awarded based on the day to day performance as Internal Marks.
- 7.3 For the courses like Seminars/Mini project/Mini Project with Seminar, there shall be an internal evaluation for 100 marks by the PRC. For Seminars/Mini project/Mini Project with Seminar, a student under the supervision of a faculty member, shall collect the literature on a topic and critically review the literature and submit it to the department in a report form/fabricated model and shall make an oral presentation before the Project Review Committee consisting of Head of the Department, Supervisor and two other senior faculty members of the department. A candidate has to secure a minimum of 50% of marks to be declared as passed.
- 7.4 A candidate shall be deemed to have secured the minimum academic requirement in a subject if he secures a minimum of 40% of marks in the End Semester Examination and a minimum aggregate of 50% of the total marks in the End Semester Examination and Internal Evaluation taken together.
- 7.5 In case the candidate does not secure the minimum academic requirement in any subject (as specified in 7.4) he has to reappear for the End Semester Examination in that subject. A candidate shall be given one chance to re-register for each subject provided the internal marks secured by a candidate are less than 50% and has failed in the End Examination. In such a case, the candidate must re-register for the subject(s) and secure the required minimum attendance. The candidate's

attendance in the re-registered subject(s) shall be calculated separately to decide upon his eligibility for writing the End Examination in those subject(s). In the event of the student taking another chance, his internal marks and End Examination marks obtained in the previous attempt stand cancelled. For re-registration, the candidates have to follow the procedures constituted by the Academic Council before the start of the semester in which re-registration is required.

7.6 In case the candidate secures less than the required attendance in any re registered subject (s), he shall not be permitted to write the End Examination in that subject. He shall again re-register the subject when next offered.

7.7 Laboratory examination for M. Tech. courses must be conducted with two examiners, one of them being the Laboratory Class Teacher or teacher of the respective college and the second examiner shall be appointed by the Controller of Examinations from the panel of 4 examiners submitted by the respective HoD.

8. EVALUATION OF PROJECT/DISSERTATION WORK

Dissertation work is divided into Dissertation-I and Dissertation-II

Dissertation-I:

The work on dissertation-I shall be initiated at the beginning of the III Semester and the duration of the Dissertation-I is six months. This includes identification of research problem and collection of relevant data based on literature survey. A student under the supervision of a faculty member shall collect the literature on a topic and critically review the literature and submit it to the department in a report (Plagiarism Checked) form and shall make an oral presentation before the Project Review Committee consisting of Head of the Department, Supervisor and two other senior faculty members of the department. This is to be approved by the PRC. The PRC shall jointly report the candidate's work as Excellent/Good/Satisfactory/Unsatisfactory.

The Head of the Department shall coordinate and make arrangements for the conduct of Viva-voce examination.

Dissertation-II:

The work starts in IV semester and it is the continuation work of Dissertation I. It includes execution of research of Dissertation I Results, Analysis and conclusion of the executed work.

8.1 Registration of Project Work: A candidate is permitted to register for the Project Work after satisfying the attendance requirement of all the subjects, both theory and practical.

8.2 If a candidate wishes to change his Supervisor or topic of the project, he can do so with the approval of the Project Review Committee (PRC). However, the Project Review Committee (PRC) shall examine whether or not the change of topic/Supervisor leads to a major change

of his initial plans of project proposal. If yes, his date of registration for the Project Work starts from the date of change of Supervisor or topic as the case may be.

- 8.3 A candidate shall submit his status report in two stages at least with a gap of 3 months between them.
- 8.4 The work on the project shall be initiated at the beginning of the II year and the duration of the project is two semesters. A candidate is permitted to submit Project Dissertation (Plagiarism-checked report countersigned by the Supervisor to be submitted in the Exam Cell) only after successful completion of theory and practical course with the approval of PRC not earlier than 40 weeks from the date of registration of the Project Work. The candidate has to pass all the theory and practical subjects before submission of the Thesis.
- 8.5 Three copies of the Project Dissertation certified by the Supervisor shall be submitted to the College.
- 8.6 The Dissertation shall be adjudicated by one Examiner selected by the Chief Controller of Examinations. For this, the Head of the Department shall submit a panel of 4 examiners, eminent in that field, with the help of the Supervisor concerned.
- 8.7 If the report of the Examiner is not favourable, the candidate shall revise and resubmit the Dissertation, in the time frame as decided by the PRC. If the report of the examiner is unfavorable again, the Dissertation shall be summarily rejected. The candidate has to re-register for the project and complete the project within the stipulated time after taking the approval from the Head of the Institution.
- 8.8 If the report of the Examiner is favorable, Viva-voce Examination shall be conducted by a board consisting of the Supervisor, Head of the Department and the Examiner who adjudicated the Dissertation. The Board shall jointly report the candidate's work as Excellent /Good /Satisfactory /Unsatisfactory.

The Head of the Department shall coordinate and make arrangements for the conduct of Viva-voce Examination.

- 8.9 If the report of the Viva-voce is unsatisfactory, the candidate shall retake the Viva-voce Examination only after three months. If he fails to get a minimum grade of SATISFACTORY at the second Viva-voce examination, the candidate has to re-register for the project and complete the project within the stipulated time after taking the approval from the Head of the Institution.

9. AWARD OF GRADES

A letter grade and grade points shall be awarded to a student in each course based on his/her performance as per the 10-point grading system given below:

Marks Range Theory (Max-100)	Marks Range Lab (Max-100)	Letter Grade	Level	Grade Point
≥90	≥90	O	Outstanding	10
80 to < 90	80 to < 90	S	Excellent	9
70 to <80	70 to <80	A	Very Good	8
60 to <70	60 to <70	B	Good	7
50 to <60	50 to <60	C	Fair	6
<50	<50	F	Fail	0
			Absent	0

10. COMPUTATION OF GRADES

SGPA:

The following procedure is to be adopted to compute the Semester Grade Point Average (SGPA) and Cumulative Grade Point Average (CGPA)

The SGPA is the ratio of sum of the product of the number of credits with the grade points by a student in all the courses taken by a student and the sum of the number of credits of all the courses undertaken by a student i.e.,

$$\text{SGPA } (S_i) = \Sigma (C_i \times G_i) / \Sigma C_i$$

Where C_i is the number of credits of the i^{th} course and G_i is the grade point scored by the student in the i^{th} course.

CGPA:

The CGPA is also calculated in the same manner taking into account all the courses undertaken by a student over all the semesters of a programme i.e.,

$$\text{CGPA} = \Sigma (C_i \times S_i) / \Sigma C_i$$

Where S_i is the SGPA of the i^{th} semester and C_i is the total number of credits in that semester.

The SGPA and CGPA is rounded off to 2 decimal points and reported in transcripts.

$$\text{Equivalent Percentage} = (\text{CGPA} \times 0.75) \times 10$$

11. AWARD OF CLASS

After a student has satisfied the minimum requirements prescribed for the completion of a programme and is eligible for the award of M.Tech degree, he/she shall be placed in one of the following four classes on a 10 point scale.

Class Awarded	CGPA
First Class with Distinction	≥ 7.75
First Class	6.75 to < 7.75
Second Class	5.75 to < 6.75
Pass Class	5.0 to < 5.75

12. DISCIPLINE

A student is required to observe discipline and decorum both inside and outside the college and not to indulge in any activity that may tarnish the prestige of the college. The Head of the Institution shall constitute a Disciplinary Committee to enquire into acts of indiscipline and notify the college about the disciplinary action taken. In case of any serious disciplinary action, which leads to suspension or dismissal, a committee shall be constituted by the Head of the Institution for taking final decision.

Those students who indulge in examination-related malpractices shall be punished as per the scale of punishment notified by JNTUK, Kakinada (Annexure-I).

Those students involved in the illegal acts of ragging shall be punished as per the provisions of Act 26, 1997 of Govt. of Andhra Pradesh (Annexure-II).

13. REVISION OF REGULATIONS, CURRICULUM AND SYLLABI

The college may revise, amend or change the regulations, curriculum, syllabus and scheme of examinations from time to time subject to decisions/recommendations of Boards of Studies and the College Academic Council.

14. WITHHOLDING OF RESULTS

If a student has not cleared dues, if any, payable to the institution or any case of indiscipline is pending against him, the result of the student will be withheld. Also, the award of his/her degree is withheld in such cases.

15. TRANSITORY REGULATIONS

A student, who is detained or who has discontinued in the semester, on readmission shall be required to do all the courses in the curriculum prescribed for the batch of students in which the student joins subsequently. However, exemption will be given to those students who have already passed courses in the earlier semester(s) he/she was originally admitted into and substitute courses are offered in place of these courses as approved by the Board of Studies.

In general, after transition, there will be a fitment formula approved by the competent authority in order to balance course composition and the number of credits.

Students admitted by transfer from other institutions shall follow transitory regulations with suitable fitment formulae approved by the competent authority.

A student who is seeking readmission shall apply in the prescribed format within one week after the commencement of the class work. However, the readmission of a student shall be approved by the competent authority.

16. GENERAL

- (i) Wherever the words “he”, “him”, “his” occur in the regulations, they include “she”, “her”, “hers”.
- (ii) The academic regulations should be read as a whole for the purpose of any interpretation.
- (iii) In case of any doubt or ambiguity in the interpretation of the above rules, decision of the Chairman of the CAC is final and binding.
- (iv) The college may change or amend academic regulations or syllabi at any time subject to the approval of the competent authority and the changes or amendments made shall be applicable to all students with effect from the dates notified.

17. STATUTORY DECLARATION

In case the regulations do not specify application of an appropriate rule in a unique case, the decision of the competent authority of the college shall be final.

* * * * *

ANNEXURE-I
MALPRACTICE RULES

DISCIPLINARY ACTION FOR MALPRACTICE/ IMPROPER CONDUCT IN EXAMINATIONS

	Nature of Malpractices/Improper Conduct	Punishment
1(a)	If a student possesses or tries to access any paper, note book, programmable calculators, Cell phones, pager, palm computers or any other form of material concerned with or related to the subject of the examination(theory or practical) in which he is appearing but has not made use of(material shall include any marks on the body of the candidate which can be used as an aid in the subject of the examination)...	Expulsion from the examination hall and cancellation of the performance in that subject only.
(b)	If a student gives assistance or guidance or receives any such help from any other candidate orally or through gestures, communicates through cell phones with any candidate or persons in or outside the exam hall...	Expulsion of all the candidates involved from the examination hall and cancellation of the performance in that subject. In case of an outsider, he shall be handed over to the police and a case will be registered against him.
2.	If a student is found to have copied in the examination hall from any paper, book, programmable calculators, palm computers or any other form of material relevant to the subject of the examination (theory or practical) in which he/she is appearing...	Expulsion from the examination hall and cancellation of the performance in that subject as well as all other subjects the candidate has already appeared including practical examinations and Project Work and shall not be permitted to appear in the remaining examinations of that Semester. The Hall Ticket of the candidate shall be cancelled and sent to the Principal.

<p>3.</p>	<p>If a student impersonates any other candidate in connection with the examination...</p>	<p>The candidate who has impersonated shall be expelled from examination hall. The candidate is also debarred from the college and forfeits his seat. The performance of the original candidate who has been impersonated, shall be cancelled in all the subjects of the examination (including practicals and project work) already appeared and shall not be allowed to appear in examinations of the remaining subjects of that semester. The candidate is also debarred for two consecutive semesters from class work and all End examinations. The continuation of the course by the candidate is subject to the academic regulations in connection with forfeiture of seat. If the imposter is an outsider, he will be handed over to the police and a case is registered against him.</p>
<p>4.</p>	<p>If a student smuggles inside the exam hall an answer book or additional sheet or takes out or arranges to send out the question paper, or answer book or additional sheet during or after the examination...</p>	<p>Expulsion from the examination hall and cancellation of performance in that subject and all the other subjects, the candidate has already appeared including practical examinations and Project Work; and shall not be permitted for the remaining examinations of the subjects of that semester. The candidate is also debarred from class work for two consecutive semesters and all end examinations. The continuation of the course by the candidate is subject to the academic regulations in connection with forfeiture of seat.</p>

5.	If a student uses objectionable, abusive or offensive language in the answer paper or in letters to the examiners or writes to the examiner requesting/threatening him/her to award pass marks...	Cancellation of the performance in that subject.
6.	If a student refuses to obey the orders of the Chief Superintendent / CoE / any officer on duty or misbehaves or creates disturbance of any kind in and around the examination hall or organizes a walk out or instigates others to walk out, or threatens the officer-in charge or any person on duty in or outside the examination hall, causes injury to his person or to any other persons whether by words, either spoken or written or by signs or by visible representation, assaults the officer-in-charge, or any person on duty in or outside the examination hall or indulges in any other act of misconduct or mischief, which result in damage to or destruction of property in the examination hall or any part of the college campus or engages in any other act which in the opinion of the officer on duty amounts to use of unfair means or misconduct or has the tendency to disrupt the orderly conduct of the examination...	Such a student shall be expelled from the examination hall along with cancellation of his performance in that subject and all other subjects the candidate has already appeared and shall not be permitted to appear for the remaining examinations of the subjects of that semester. The candidate shall be debarred from the college and he forfeits his seat. In case of outsiders, they will be handed over to the police and a police case shall be registered against them.

7.	If a student leaves the exam hall taking away answer script or intentionally tears/mutilates/deforms the script or any part thereof inside or outside the examination hall...	Expulsion from the examination hall and cancellation of performance in that subject and all the other subjects the candidate has already appeared, including practical examinations and Project Work and shall not be permitted for the remaining examinations of the subjects of that semester. The candidate is also debarred from class work and End examinations for two consecutive semesters. The continuation of the course by the candidate is subject to the academic regulations.
8.	If a student is in possession of any lethal weapon or firearm in the examination hall...	Expulsion from the examination hall and cancellation of the performance in that subject and all other subjects the candidate has already appeared including practical examinations and Project Work and shall not be permitted for the remaining examinations of the subjects of that semester. The candidate is also debarred and he forfeits the seat.
9.	If a student of the college, who is not a candidate for the particular examination or any person not connected with the college indulges in any malpractice or improper conduct mentioned in clause 6 to 8...	Expulsion from the examination hall and cancellation of the performance in that subject and all other subjects the candidate has already appeared including practical examinations and Project Work and shall not be permitted for the remaining examinations of the subjects of that semester. The candidate is also debarred and he forfeits the seat. Person(s) who do not belong to the College will be handed over to police and, a police case will be registered against them.

10.	If a student comes to the examination hall in a drunken condition...	Expulsion from the examination hall and cancellation of the performance in that subject and all other subjects the candidate has already appeared including practical examinations and Project Work and shall not be permitted for the remaining examinations of that semester.
11.	If copying is detected on the basis of internal evidence, such as, during valuation or during special scrutiny...	Cancellation of the performance in that subject and all other subjects the candidate has appeared including practical examinations and Project Work of that semester examinations.
12.	Any other malpractice not covered in the above clauses i.e. from 1 to 11 shall be reported to the Principal for further action/ suitable punishment.	





ANNEXURE-II

Ragging

Prohibition of ragging in educational institutions Act 26 of 1997

Salient Features

- Ragging within or outside any educational institution is prohibited.
- Ragging means doing an act which causes or is likely to cause Insult or Annoyance of Fear or Apprehension or Threat or Intimidation or outrage of modesty or Injury to a student

	Imprisonment up to		Fine Up to
Teasing, Embarrassing and Humiliation	 6 Months	+	Rs. 1,000/-
Assaulting or Using Criminal force or Criminal intimidation	 1 Year	+	Rs. 2,000/-
Wrongfully restraining or confining or causing hurt	 2 Years	+	Rs. 5,000/-
Causing grievous hurt, kidnapping or Abduction or rape or committing unnatural offence	 5 Years	+	Rs. 10,000/-
Causing death or abetting suicide	 10 Years	+	Rs. 50,000/-

ABSOLUTE NO TO RAGGING

1. Ragging is prohibited as per Act 26 of A.P. Legislative Assembly, 1997.
2. Ragging entails heavy fines and/or imprisonment.
3. Ragging invokes suspension and dismissal from the College.
4. Outsiders are prohibited from entering the College and Hostel without permission.
5. All the students must carry their Identity Cards and show them when demanded.
6. The Principal and the Wardens may visit Hostels and inspect the rooms any time.

* * * * *